

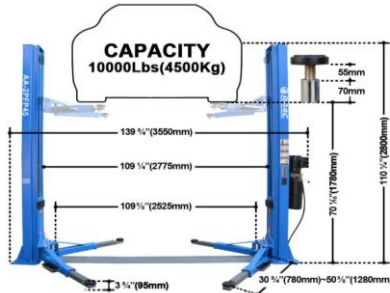





8 fold profile columns 2 post lift Quotation sheet

<p>Price : \$850/UNIT EXW term for LCL order FOB term for FCL order(28units/20gp)</p>		<p>Model No. AA-2PFP45 2 Post lift, Floorplate,4.5T(10000lbs) 8 fold profiles column, Manual unlock</p>	
<p>220v50hz,1ph; 380V50HZ,3PH</p>	<p>Standard</p>	<p>Video link: https://youtu.be/IHAFI-iATDM</p>	
<p>Floorplate 2 post lift</p>			
Lifting capacity:	4.5T(10000lbs)		
Max lifting height:	1780mm		
Overall height:	2800mm		
Overall width:	3420mm		
Long Arm Length	680~1020mm		
Short Arm Length	860~1300mm		
Net weight :	570KG		
<p>Unlocking mode: Manual unlock</p> <p>Features:</p> <ol style="list-style-type: none"> 1. Intern arm lock 2. Equiped with door protectors 3. Equiped with 4 pcs 2 stage arms 4. Iron motor+Iron oil tank 			

Features (Standard included)

				
Intern arm lock	2 stages arm	Door protector	single spiral screw-up tray	Power unit packed with posts, 1 package per unit
				
8 folded column ("S" shape)	Foot protection with tray	7cm Extensive adaptor	Iron motor+ plastic oil tank	forged arm lock

Optional parts:







		
Strengthen basement :\$50/set	2pcs 3 stage arms + \$35/unit	110V/60HZ,1PH MOTOR + \$15/unit

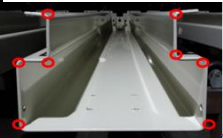

8 fold profile columns 2 post lift Quotation sheet

<p>Price : \$975/UNIT EXW term for LCL order FOB term for FCL order(28units/20gp)</p>		<p>Model No. AA-2PPF45E 2 Post lift, Floorplate,4.5T(10000lbs) 8 fold profiles column, Electrical unlock</p>	
<p>220v50hz,1ph; 380V50HZ,3PH</p>	<p>Standard</p>		
<p>Floorplate 2 post lift</p>			
Lifting capacity:	4.5T(10000lbs)		
Max lifting height:	1780mm		
Overall height:	2800mm		
Overall width:	3420mm		
Long Arm Length	680~1020mm		
Short Arm Length	860~1300mm		
Net weight :	590KG		
<p>Unlocking mode: Electrical unlock</p> <p>Features:</p> <ol style="list-style-type: none"> Intern arm lock Equiped with door protectors Equiped with 4 pcs 2 stage arms Iron motor+Iron oil tank 			

Features (Standard included)

				
Intern arm lock	2 stages arm	Door protector	single spiral screw-up tray	Power unit packed with posts, 1 package per unit
				
8 folded column ("S" shape)	Foot protection with tray	7cm Extensive adaptor	Iron motor+ plastic oil tank	Control box

Optional parts:







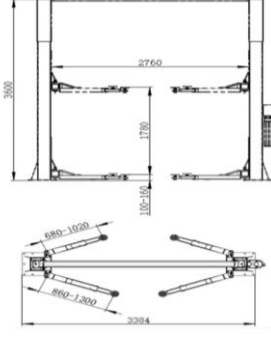

			
Strengthen basement :\$50/set	2pcs 3 stage arms + \$35/unit	110V/60HZ,1PH MOTOR + \$15/unit	forged arm lock

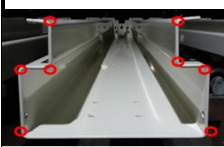

8 fold profile columns 2 post lift Quotation sheet

<p>Price : \$930/UNIT EXW term for LCL order FOB term for FCL order(28units/20gp)</p>		<p>Model No. AA-2PCF45 2 Post lift, ClearFloor,4.5T(10000lbs) 8 fold profiles column, Manual unlock</p>	
<p>220v50hz,1ph; 380V50HZ,3PH</p>	<p>Standard</p>	 	
<p>Clearfloor 2 post lift</p>			
<p>Lifting capacity:</p>	<p>4.5T</p>		
<p>Max lifting height:</p>	<p>1780mm</p>		
<p>Overall height:</p>	<p>3600mm</p>		
<p>Overall width:</p>	<p>3384mm</p>		
<p>Long Arm Length</p>	<p>680~1020mm</p>		
<p>Short Arm Length</p>	<p>860~1300mm</p>		
<p>Net weight :</p>	<p>600KG</p>		
<p>Unlocking mode: Manual unlock</p> <p>Features:</p> <ol style="list-style-type: none"> Intern arm lock Equiped with door protectors Equiped with 4 pcs 2 stage arms Iron motor+Iron oil tank 2 segment columns 			

Features (Standard included)

 <p>Intern arm lock</p>	 <p>2 stages arm</p>	 <p>Door protector</p>	 <p>single spiral screw-up tray</p>	 <p>Power unit packed with posts, 1 package per unit</p>
 <p>8 folded column ("S" shape)</p>	 <p>Foot protection with tray</p>	 <p>7cm Extensive adaptor</p>	 <p>Iron motor+ plastic oil tank</p>	 <p>forged arm lock</p>

Optional parts:







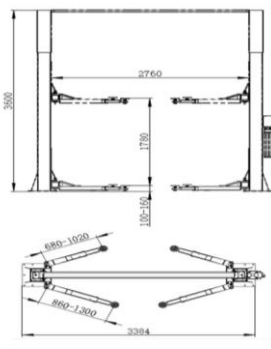

 <p>Strengthen basement :\$50/set</p>	 <p>2pcs 3 stage arms + \$35/unit</p>	 <p>110V/60HZ,1PH MOTOR + \$15/unit</p>
--	--	--

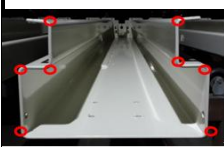

8 fold profile columns 2 post lift Quotation sheet

<p>Price : \$990/UNIT EXW term for LCL order FOB term for FCL order(28units/20gp)</p>		<p>Model No. AA-2PCF45S 2 Post lift, ClearFloor,4.5T(10000lbs) 8 fold profiles column, single side Manual unlock</p>	
<p>220v50hz,1ph; 380V50HZ,3PH</p>	<p>Standard</p>	 	
<p>Clearfloor 2 post lift</p>			
Lifting capacity:	4.5T		
Max lifting height:	1780mm		
Overall height:	3600mm		
Overall width:	3384mm		
Long Arm Length	680~1020mm		
Short Arm Length	860~1300mm		
Net weight :	600KG		
<p>Unlocking mode: single side Manual unlock</p> <p>Features:</p> <ol style="list-style-type: none"> Intern arm lock Equiped with door protectors Equiped with 4 pcs 2 stage arms Iron motor+Iron oil tank 2 segment columns 			

Features (Standard included)



				
Intern arm lock	2 stages arm	Door protector	single spiral screw-up tray	Power unit packed with posts, 1 package per unit
				
8 folded column ("S" shape)	Foot protection with tray	7cm Extensive adaptor	Iron motor+ plastic oil tank	Single side manual release

Optional parts:







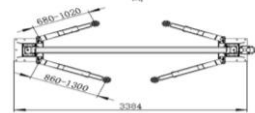

			
Strengthen basement :\$50/set	2pcs 3 stage arms +\$35/unit	110V/60HZ,1PH MOTOR +\$15/unit	forged arm lock

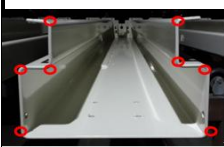

8 fold profile columns 2 post lift Quotation sheet

Price : \$1050/UNIT EXW term for LCL order FOB term for FCL order(28units/20gp)		Model No. AA-2PCF45E 2 Post lift, ClearFloor,4.5T(10000lbs) 8 fold profiles column, Electrical unlock	
220v50hz,1ph; 380V50HZ,3PH	Standard	  	
Clearfloor 2 post lift			
Lifting capacity:	4.5T		
Max lifting height:	1780mm		
Overall height:	3600mm		
Overall width:	3384mm		
Long Arm Length	680~1020mm		
Short Arm Length	860~1300mm		
Net weight :	600KG		
Unlocking mode: Electrical unlock Features: 1. Intern arm lock 2. Equiped with door protectors 3. Equiped with 4 pcs 2 stage arms 4. Iron motor+Iron oil tank 5. 2 segment columns			

Features (Standard included)

				
Intern arm lock	2 stages arm	Door protector	single spiral screw-up tray	Power unit packed with posts, 1 package per unit
				
8 folded column ("S" shape)	Foot protection with tray	7cm Extensive adaptor	Iron motor+ plastic oil tank	Control box

Optional parts:

			
Strengthen basement :\$50/set	2pcs 3 stage arms + \$35/unit	110V/60HZ,1PH MOTOR + \$15/unit	forged arm lock